



JBL PARTYBOX 720



OWNER'S MANUAL

IMPORTANT SAFETY INSTRUCTIONS

For all products:

1. Clean only with a dry cloth.
2. Do not block any ventilation openings. Install this apparatus in accordance with the manufacturer's instructions.
3. Do not install this apparatus near any heat sources such as radiators, heat registers, stoves or other apparatus (including amplifiers) that produce heat.
4. Do not defeat the safety purpose of the polarized or grounding-type plug. A polarized plug has two blades with one wider than the other. A grounding-type plug has two blades and a third grounding prong. The wide blade or the third prong is provided for your safety. If the provided plug does not fit into your outlet, consult an electrician for replacement of the obsolete outlet.
5. Protect the power cord from being walked on or pinched, particularly at plugs, convenience receptacles and the point where they exit from the apparatus.
6. Use only attachments/accessories specified by the manufacturer.
7. Use only with the cart, stand, tripod, bracket or table specified by the manufacturer or sold with the apparatus. When a cart is used, use caution when moving the cart/apparatus combination to avoid injury from tip-over. 
8. Unplug this apparatus during lightning storms or when unused for long periods of time.
9. Refer all servicing to qualified service personnel. Servicing is required when the apparatus has been damaged in any way, such as when the power-supply cord or plug is damaged, liquid has been spilled or objects have fallen into the apparatus, or the apparatus has been exposed to rain or moisture, does not operate normally or has been dropped.
10. To disconnect this apparatus from the AC mains completely, disconnect the power-supply cord plug from the AC receptacle.
11. The mains plug of the power-supply cord shall remain readily operable.
12. This apparatus is intended to be used only with the power supply and/or charging cable provided by the manufacturer.

The following instructions may not apply to waterproof devices. Refer to your device user manual or quick start guide for more waterproof instruction if any.

- Do not use this apparatus near water.
- Do not expose this apparatus to dripping or splashing, and ensure that no objects filled with liquids, such as vases, are placed on the apparatus.

WARNING:

- TO REDUCE THE RISK OF FIRE OR ELECTRIC SHOCK, DO NOT EXPOSE THIS APPARATUS TO RAIN OR MOISTURE.

CAUTION

RISK OF ELECTRIC SHOCK. DO NOT OPEN.



THIS SYMBOL ON THE PRODUCT MEANS THERE IS UNINSULATED, DANGEROUS VOLTAGE WITHIN THE PRODUCT ENCLOSURE THAT MAY PRESENT A RISK OF ELECTRICAL SHOCK.



THIS SYMBOL ON THE PRODUCT MEANS THERE ARE IMPORTANT OPERATING AND MAINTENANCE INSTRUCTIONS IN THIS GUIDE.

CAUTION FCC AND IC STATEMENT FOR USERS

This device complies with part 15 of the FCC Rules. Operation is subject to the following two conditions: (1) This device may not cause harmful interference, and (2) this device must accept any interference received, including interference that may cause undesired operation.

CAN ICES(B)/NMB(B)

FCC SDOC SUPPLIER'S DECLARATION OF CONFORMITY

HARMAN International hereby declares that this equipment is in compliance with the FCC Part 15 Subpart B.

Federal Communication Commission Interference Statement

This equipment has been tested and found to comply with the limits for a Class B digital device, pursuant to Part 15 of the FCC Rules. These limits are designed to provide reasonable protection against harmful interference in a residential installation. This equipment generates, uses and can radiate radio frequency energy and, if not installed and used in accordance with the instructions, may cause harmful interference to radio communications. However, there is no guarantee that interference will not occur in a particular installation. If this equipment does cause harmful interference to radio or television reception, which can be determined by turning the equipment off and on, the user is encouraged to try to correct the interference by one or more of the following measures:

- Reorient or relocate the receiving antenna.
- Increase the separation between the equipment and receiver.
- Connect the equipment into an outlet on a circuit different from that to which the receiver is connected.
- Consult the dealer or an experienced radio/TV technician for help.

Caution:

- Changes or modifications not expressly approved by HARMAN could void the user's authority to operate the equipment.

For Products That Transmit RF Energy:

(i) This device contains licence-exempt transmitter(s)/ receiver(s) that comply with Innovation, Science and Economic Development Canada's licence-exempt RSS(s). Operation is subject to the following two conditions:

1. This device may not cause interference.
2. This device must accept any interference, including interference that may cause undesired operation of the device.

(ii) Radiation Exposure statement

This equipment complies with FCC and IC RSS-102 radiation exposure limits set forth for an uncontrolled environment.

For radio equipment operates in 5150-5850MHz

FCC and IC Caution:

High power radars are allocated as primary users of the 5.25 to 5.35 GHz and 5.65 to 5.85 GHz bands. These radar stations can cause interference with and/or damage to LE LAN (Licence-Exempt Local Area Network) devices. No configuration controls are provided for this wireless equipment allowing any change in the frequency of operations outside the FCC grant of authorization for US operation according to Part 15.407 of the FCC rules.

IC Caution:

User should also be advised that:

1. The device for operation in the band 5150 - 5250 MHz is only for indoor use to reduce the potential for harmful interference to co-channel mobile satellite systems;
2. The maximum antenna gain permitted for devices in the bands 5250 - 5350 MHz and 5470 - 5725 MHz shall comply with the e.i.r.p. limit: and
3. The maximum antenna gain permitted for devices in the band 5725 - 5825 MHz shall comply with the e.i.r.p. limits specified for point-to-point and non point-to-point operation as appropriate.

Use Restriction Attention in European Union, operation is limited to indoor use within the band 5150-5350 MHz.

Correct disposal of this product (Waste Electrical & Electronic Equipment)

This symbol means the product must not be discarded as household waste, and should be delivered to an appropriate collection facility for recycling. Proper disposal and recycling helps protect natural resources, human health and the environment. For more information on disposal and recycling of this product, contact your local municipality, disposal service, or the shop where you bought this product.



This product is RoHS compliant.

This product is in compliance with Directive 2011/65/EU and UK The Restriction of the Use of Certain Hazardous Substances in Electrical and Electronic Equipment Regulations 2012, and its amendments, on the restriction of the use of certain hazardous substances in electrical and electronic equipment.

REACH

REACH (Regulation No 1907/2006) addresses the production and use of chemical substances and their potential impacts on human health and the environment. Article 33(1) of REACH Regulation requires suppliers to inform the recipients if an article contains more than 0.1 % (per weight per article) of any

substance(s) on the Substances of Very High Concern (SVHC) Candidate List ('REACH candidate list'). This product may contain the substance "lead"(CAS-No. 7439-92-1) in a concentration of more than 0.1% per weight.

At the time of release of this product, except for the lead substance, no other substances of REACH candidate list are contained in a concentration of more than 0.1% per weight in this product.

Note:

- On June 27, 2018, lead was added to the REACH candidate list. The inclusion of lead in the REACH candidate list does not mean that lead-containing materials pose an immediate risk or results in a restriction of permissibility of its use.

For devices with headphone jacks

WARNINGS/CAUTIONS



Do NOT use the headphones at a high volume for any extended period.

- To avoid hearing damage, use your headphones at a comfortable, moderate volume level.
- Turn the volume down on your device before placing the headphones on your ears, then turn the volume up gradually until you reach a comfortable listening level.

For Products That Include Batteries

Instructions for Users on Removal, Recycling and Disposal of Used Batteries

To remove the batteries from your equipment or remote control, reverse the procedure described in the owner's manual for inserting batteries. For products with a built-in battery that lasts for the lifetime of the product, removal may not be possible for the user. In this case, recycling or recovery centers handle the dismantling of the product and the removal of the battery. If, for any reason, it becomes necessary to replace such a battery, this procedure must be performed by authorized service centers. In the European Union and other locations, it is illegal to dispose of any battery with household trash. All batteries must be disposed of in an environmentally sound manner. Contact your local waste-management officials for information regarding the environmentally sound collection, recycling and disposal of used batteries.

WARNING:

- Danger of explosion if battery is incorrectly replaced. To reduce risk of fire, explosion or leakage of flammable liquid/gas, don't disassemble, crush, puncture, short external contacts, expose to temperature above 60°C (140°F), sunshine or like, expose to extremely low air pressure or dispose of in fire or water. Replace only with specified batteries. The symbol indicating 'separate collection' for all batteries and accumulators shall be the crossed-out wheeled bin shown below:



WARNING - For Products Contain Coin/Button Cell Batteries

DO NOT INGEST BATTERY, CHEMICAL BURN HAZARD. This product contains a coin/button cell battery. If the coin/button cell battery is swallowed, it can cause severe internal burns in just 2 hours and can lead to death. Keep new and used batteries away from children. If the battery compartment does not close securely, stop using the product and keep it away from children. If you think batteries might have been swallowed or placed inside any part of the body, seek immediate medical attention.

For All Products with Wireless Operation:

HARMAN International hereby declares that this equipment is in compliance with the essential requirements and other relevant provisions of Directive 2014/53/EU and UK Radio Equipment Regulations 2017. The declaration of conformity may be consulted in the specs section of the product detail page, accessible from www.jbl.com or in www.jbl.com/doc.

EPILEPSY WARNING

A few people may experience epileptic seizures when viewing flashing lights.

TABLE OF CONTENTS

IMPORTANT SAFETY INSTRUCTIONS 2

1. INTRODUCTION 6

2. WHAT'S IN THE BOX 6

3. PRODUCT OVERVIEW 7

3.1 Top panel 7

3.2 Back panel 8

4. PLACEMENT 8

5. POWER ON 9

6. USING YOUR PARTYBOX 9

6.1 Bluetooth connection 9

6.2 USB connection 10

6.3 Music control 10

6.4 AUX connection 10

6.5 Mixing sound with a microphone and /
or guitar / line-in device 11

6.6 Charging your mobile device 12

6.7 Replacing batteries (JBL BATTERY 600) 12

7. CARRYING YOUR PARTYBOX 13

8. ADVANCED USAGE 13

8.1 JBL app 13

8.2 Light effect 13

8.3 Sound effect 13

8.4 Multi-speaker connection 14

8.5 Daisy chain 14

8.6 Factory reset 14

8.7 IPX4 14

9. SPECIFICATIONS 15

10. TROUBLESHOOTING 15

11. COMPLIANCE 16

12. TRADEMARK 16

1. INTRODUCTION

Congratulations on your purchase! This manual includes information about the **JBL PARTYBOX 720** speaker. We encourage you to take a few minutes to read this manual, which describes the product and includes step-by-step instructions to help you to set up and get started. Read and understand all the safety instructions before using your product.

If you have any questions about this product, its installation or operation, please contact your retailer or customer service, or visit us at www.jbl.com.

2. WHAT'S IN THE BOX



①

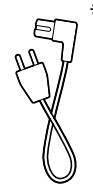

②

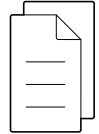

③

- 1) Main unit
- 2) Power cord*
- 3) Quick Start Guide, Safety Sheet, Warranty Card

*Power cord quantity and plug type vary by regions.

3. PRODUCT OVERVIEW

3.1 Top panel

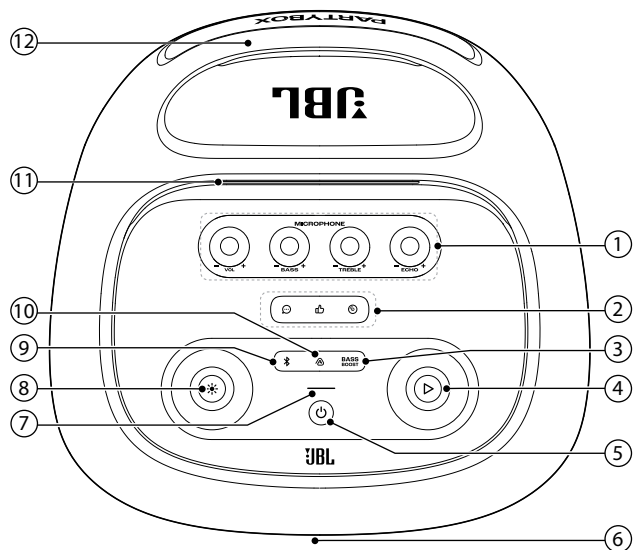

1) Microphone controls

- VOL +

- Adjust the microphone volume.

- BASS +

- Adjust the bass level.

- TREBLE +

- Adjust the treble level.

- ECHO +

- Adjust the echo level.

2) Sound effect panel

- Select a special sound effect.

3) **BASS BOOST**

- Enhance the bass level: level 1, level 2, or off.

4) ▷

- Play, pause or resume.
- Rotate clockwise / counterclockwise to increase / decrease the main volume.

5) ⏻

- Turn the power on or off.

6) LED ring

7) Battery status indicator

8) ✨

- Press to turn light effect on or off.
- Hold for more than 2 seconds to turn strobe and stary light on or off.
- Rotate clockwise / counterclockwise to switch between different light patterns.

9) ✨

- Press to enter Bluetooth pairing mode.

10) 🔊

- Press to enable or disable multi-speaker connection.

11) Mobile device dock

12) Handle

LED behavior

⏻	○ Solid white	Power on
	○ Dim white	Standby
	● Off	Power off
📶	⚡ Flashing white quickly	Pairing
	○ Solid white	Connected
	● Off	Not connected
BASS BOOST	○ Solid white	Level 2
	○ Dim white	Level 1
	● Off	Off
🔋	● Flashing red quickly	Low battery
	⚡ Flashing white slowly	Charging
	○ Solid white	The speaker is fully charged when the entire light stripe turns solid white.

Caution:

- Do not look directly at the light-emitting parts when the speaker lights are turned on.

3.2 Back panel

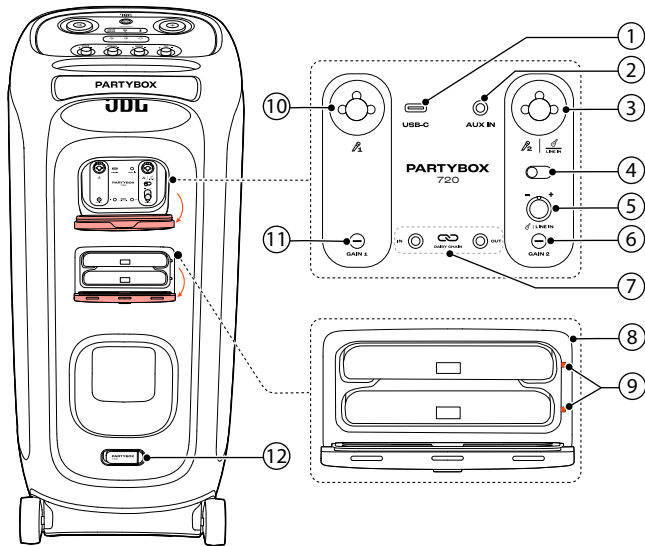

1) USB-C

- Connect to a USB storage device.
- Connect to your PC, tablet, or other mobile devices.
- Charge your mobile devices.

2) AUX IN

- Connect to an external audio device through a 3.5 mm audio cable (not supplied).

3) | | LINE IN

- Connect to a microphone, guitar, or a line-in device such as a DJ mixer.

4) Microphone 2/guitar/line-in slider switch

5) Guitar/line-in volume knob (| LINE IN)

- Adjust volume of the guitar or line-in device (if connected).

6) GAIN 2

- Adjust gain of the corresponding microphone () or guitar/line-in input.



7) IN/OUT

- Daisy-chain multiple PARTYBOX speakers through 3.5 mm audio cables (not supplied).

8) Battery compartment

- Pull down the latch to open the battery compartment.

9) Battery status indicator

	Flashing red	Low battery
	Solid red	Charging

10)

- Connect to a microphone.

11) GAIN 1

- Adjust gain of the corresponding microphone () input.

12) AC power

- Connect to AC power supply.

4. PLACEMENT

Caution:

- Do not sit or lean on the speaker or push it sideways to avoid tip-over and possible damages.

Place the speaker on a flat, stable surface and ensure that the rubber feet side is down.

5. POWER ON

Cautions:

- Use the provided power cord only.
- You can use either AC power or the built-in battery as power supply to the speaker.

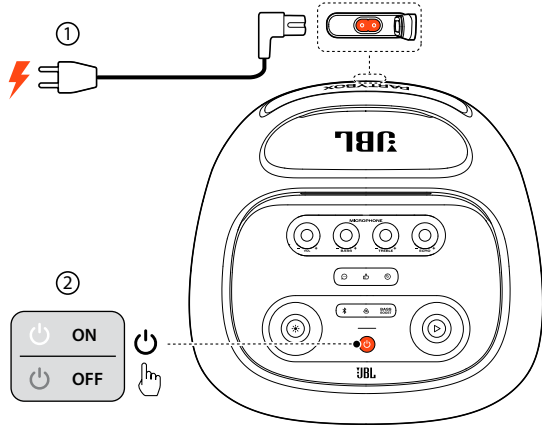

1. Connect AC power.
 - To use the built-in battery, disconnect the AC power after charging the speaker.
2. Press to power on.

Tips:

- Fully charge the speaker before first-time use to prolong the lifespan of the built-in battery.
- When the speaker is on, you can check the battery level by pressing any button on the speaker except .
- The speaker switches to standby mode automatically after 20 minutes of inactivity. You can press on the speaker to switch to normal operation.

6. USING YOUR PARTYBOX

Notes:

- Only one sound source can be played at a time.
- Starting playback from another source will always interrupt the current source.

6.1 Bluetooth connection

You can use the speaker with your Bluetooth enabled smartphone or tablet.

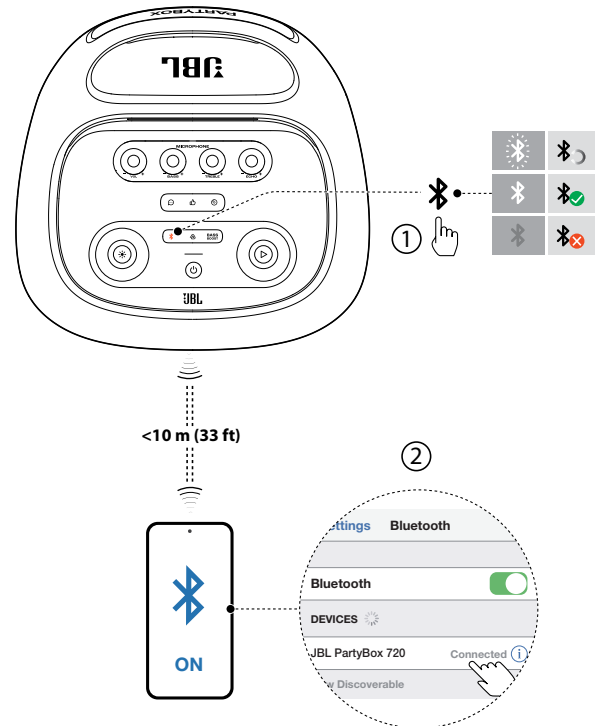

1. Press on the speaker to enter Bluetooth pairing mode.
2. Choose **JBL PartyBox 720** on your Bluetooth device to connect.
3. Once successfully connected, you can stream audio from your Bluetooth device to this speaker.

Notes:

- This speaker supports multi-point connection. You can pair a second Bluetooth device without disconnecting the first one.
- Enter “0000” if a PIN code is requested for connection to a Bluetooth device.
- Bluetooth performance can be affected by the distance between this product and your Bluetooth device and the environment of operation.

To terminate the Bluetooth-enabled device:

- Turn off this speaker, or
- Disable Bluetooth on your device.

To reconnect the Bluetooth enabled device:

- When you turn on this speaker next time, it tries to reconnect the last connected device automatically.
- If not, manually select **JBL PartyBox 720** on your Bluetooth device to connect.

6.2 USB connection

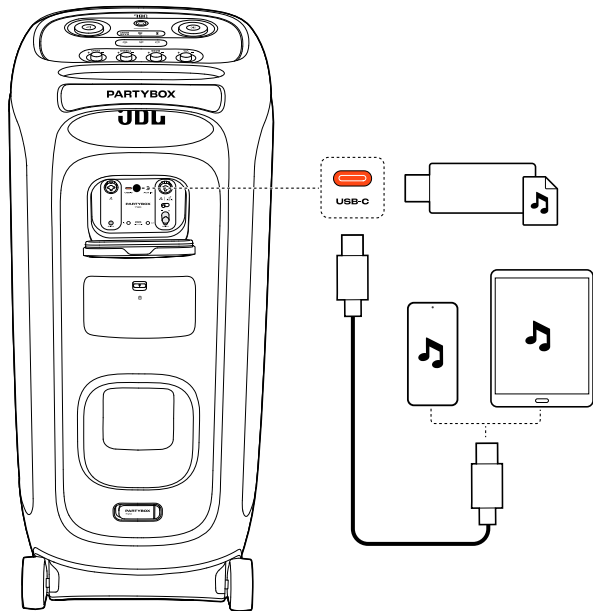

- Connect the speaker with a PC, tablet, or other mobile devices for audio playback and recording (microphone and guitar/line-in input only).
 - Plug a USB storage device that contains playable audio contents into the USB-C port of the speaker (not for EMEA region).
- The speaker switches to the USB source automatically.
 → Audio playback will start automatically.

Tip:

- The speaker plays audio files on the USB storage device from the root folder to the last level of subfolders in alphabetical sequence. Up to 8 levels of subfolders are supported.

Supported audio formats

Extension	Codec	Sample rate	Bitrate
MP3	MP1	44.1K/48K	32-448kbps
	MP2	44.1K/48K	8-384kbps
	MP3	44.1K/48K	8-320kbps
WAV	IMA-ADPCM	44.1K/48K	32-384kbps
	MS-ADPCM		
	a-law		
	u-law		
	PCM	44.1K/48K	128-1536kbps
FLAC	flac	44.1K/48K	600-1300kbps

6.2.1 Recording audio to USB storage device

Hold and **BASS BOOST** simultaneously for more than 2 seconds to start or stop recording (microphone and guitar input only).
 → When recording starts, the **BASS BOOST** LED flashes white once.
 → When recording stops, the **BASS BOOST** LED flashes white twice.

6.3 Music control

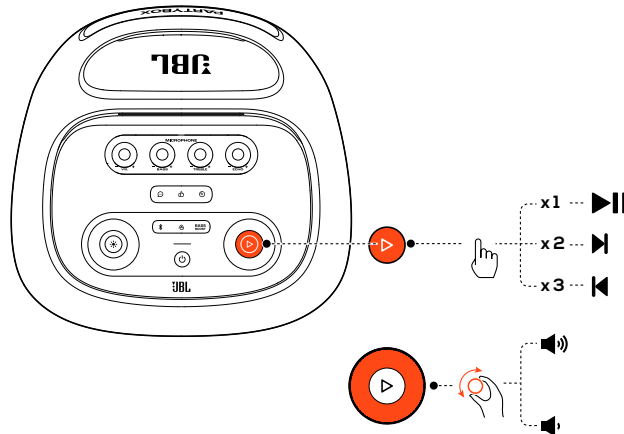

- Press once to pause or resume playback.
- Press twice to skip to the next track.
- Press three times to skip to the previous track.
- Rotate the volume knob clockwise or counterclockwise to increase or decrease the main volume.
- Press **BASS BOOST** to select a bass level: level 1, level 2, or off.

Note:

- The skip operation is unavailable in AUX mode.

6.4 AUX connection

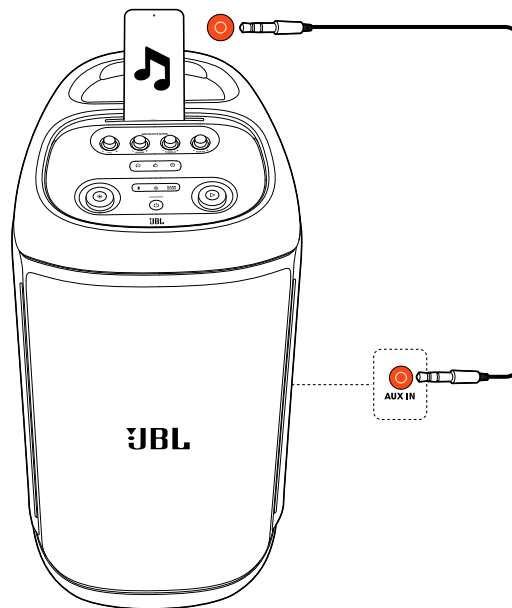

1. Connect an external audio device to the speaker through a 3.5 mm audio cable (not supplied).
 → The speaker switches to the AUX source automatically.
2. Start audio playback on the external device.

6.5 Mixing sound with a microphone and / or guitar / line-in device





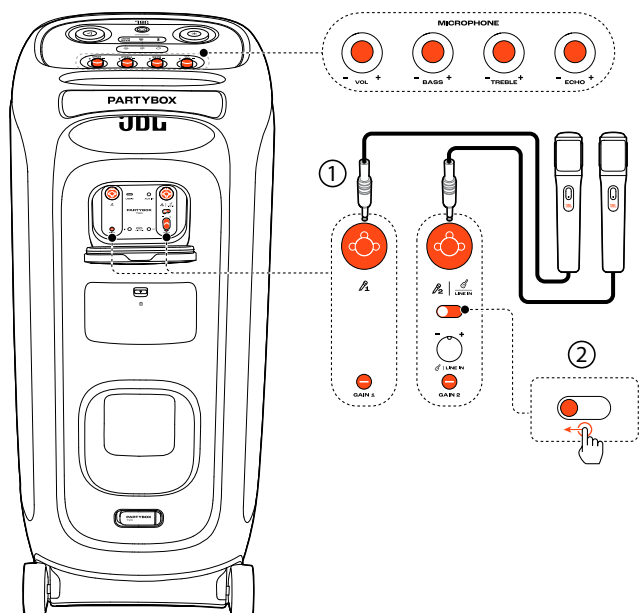

By using a microphone or electric guitar / line-in device, such as a DJ mixer (not supplied), you can mix sound with an audio source.

Notes:

- Always set the volume of the guitar / line-in device or microphone to the minimum level before connection / disconnection.
- Always disconnect the guitar / line-in device or microphone when you are not using them.



6.5.1 Connecting a microphone



1. Connect a microphone to the  or  |  LINE IN socket.
2. When connecting a microphone to the  |  |  LINE IN socket, switch the slider accordingly.

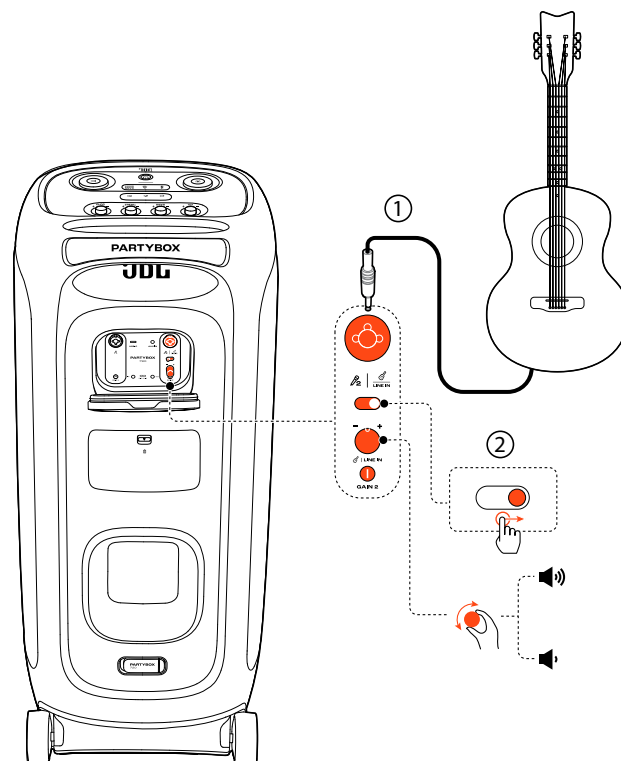

6.5.2 Connecting a guitar

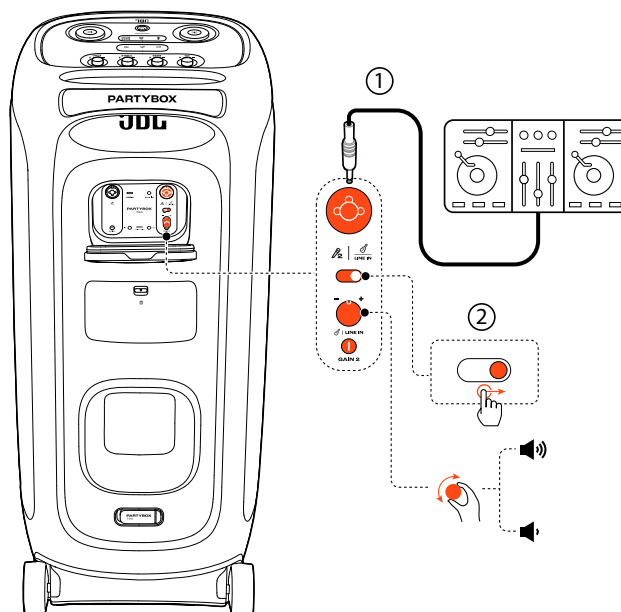

1. Connect a guitar to the  |  LINE IN socket.
2. Switch the slider accordingly.

6.5.3 Connecting a line-in device



1. Connect a line-in device, such as a DJ mixer, to the  |  LINE IN socket.
2. Switch the slider accordingly.

6.5.4 Mixing sound

Sing through the microphone or play the guitar / line-in device.

- To adjust the volume of the audio source, rotate the **▷** volume knob on the top panel clockwise or counterclockwise.
- To adjust the volume of the microphone, rotate the **- VOL +** knob on the top panel. To adjust the volume of the guitar / line-in device, rotate the **- GUITAR | LINE IN +** volume knob on the back panel.
- To adjust the gain of the microphone or guitar, rotate the **GAIN 1** or **GAIN 2** control on the back panel respectively.
- To adjust the echo, treble, and bass levels of the microphone, rotate the **- ECHO +**, **- TREBLE +**, and **- BASS +** knobs on the top panel respectively.

6.6 Charging your mobile device

Caution:

- Do not connect your speaker until the USB-C port is completely dry and clean.

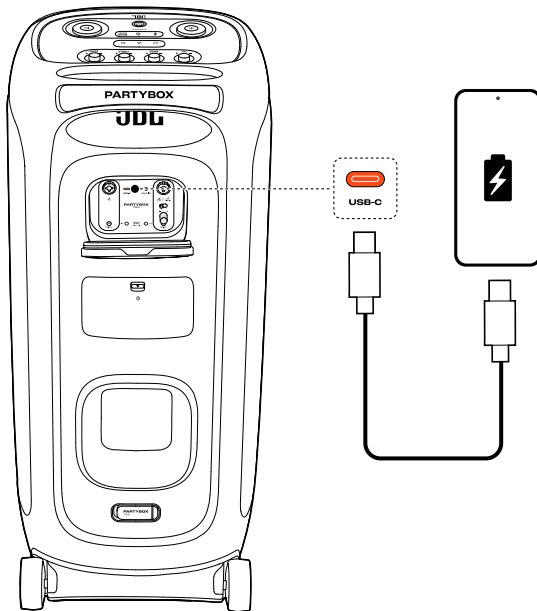

Note:

- The USB charging cable is not supplied.

6.7 Replacing batteries (JBL BATTERY 600)

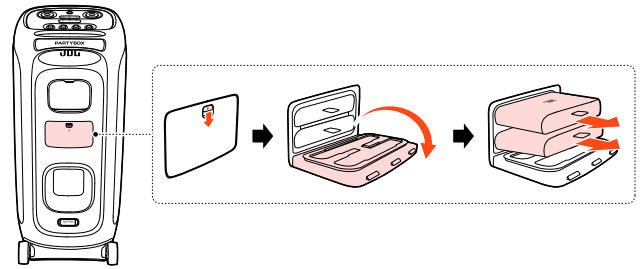

1. Pull down the latch to open the battery compartment, and then remove the old batteries.

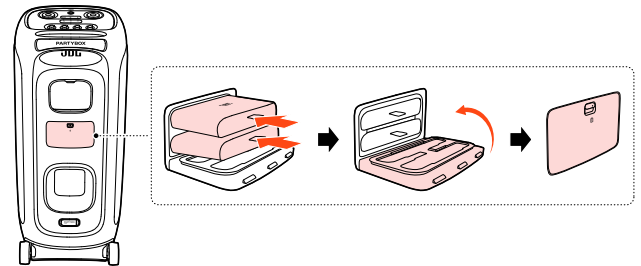

2. Insert two new batteries of the same type (JBL BATTERY 600) with the metal contacts facing down, and then close the battery cover.

Note:

- Batteries are not included for EMEA region.

7. CARRYING YOUR PARTYBOX

Cautions:

- Before carrying the speaker, ensure that all the cords are disconnected.
- To avoid personal injury and/or property damage, hold the product firmly while carrying.

The PARTYBOX 720 is designed with a handle to help you move the speaker around easily.

8. ADVANCED USAGE



8.1 JBL app

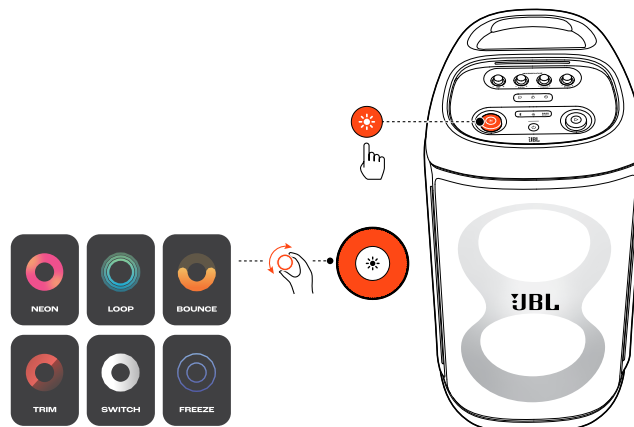

Download and install the JBL app to get more from the product.

8.2 Light effect



- Press  to turn light effect on or off.
- Hold  for more than 2 seconds to turn strobe and stary light on or off.
- Rotate the knob clockwise / counterclockwise to switch between different light patterns: NEON, LOOP, BOUNCE, TRIM, SWITCH, or FREEZE.

8.3 Sound effect

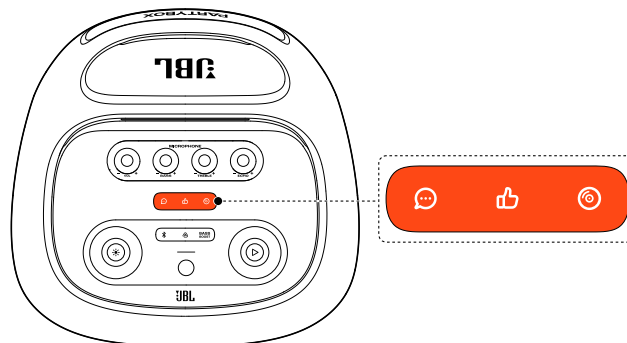

Press ,  or  to select a special sound effect.

8.4 Multi-speaker connection

You can connect two or more PARTYBOX speakers together for even bigger sound.

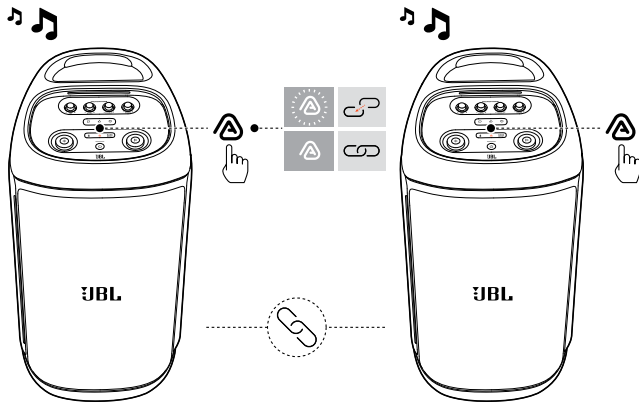

Press  on both speakers.

To disconnect:

Power off or press  on either speaker.



TIP:

- By default, the speaker connected to your Bluetooth device acts as the primary speaker.

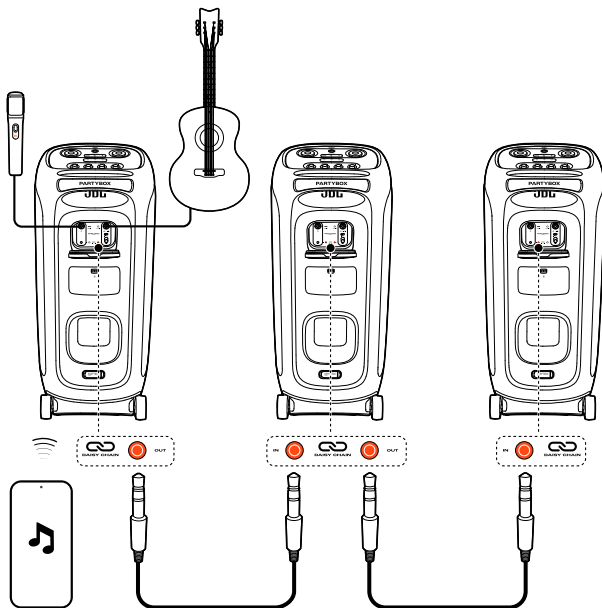
8.5 Daisy chain



8.6 Factory reset

To restore the factory settings, hold  and  for more than 10 seconds.

8.7 IPX4

Cautions:

- Always keep the charging port dry before connecting AC power.
- To ensure splash resistance, always keep the protective covers closed securely.

The speaker is IPX4 splash resistant.

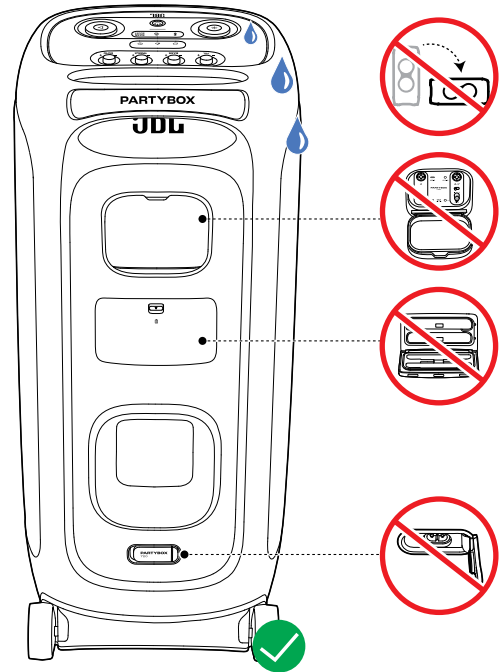

9. SPECIFICATIONS

- Transducer: 2 x 9 inch (243 mm) woofers,
2 x 1.25 inch (30 mm) dome tweeters
- Output power: 800 W RMS (IEC60268)
- Power input: 100 – 240 V ~ 50 / 60 Hz
- Frequency response: 32 Hz – 20 kHz
- Signal-to-noise ratio: > 80 dB
- Battery type (Batteries not included for EMEA region):
2 x JBL BATTERY 600 (Li-ion 99.02 Wh (equivalent to
21.6 V / 4584 mAh))
- Battery charge time: 3 hours (speaker off mode)
- Music play time: up to 15 hours (varies by volume level and
audio content)
- Cable type: AC power cable (type varies by regions)
- Cable length: 2.0 m / 6.6 ft
- USB-C charge out: PDO (5 V / 3 A, 9 V / 3 A, 15 V / 2 A,
20 V / 1.5 A max),
PPS (5 - 11 V / 2.7 A, 5 - 16 V / 1.85 A)
- USB format: FAT16, FAT32
- Supported formats (not available for EMEA region):
.MP3, .WAV, .FLAC
- Bluetooth® version: 5.4
- Bluetooth® profile: A2DP V1.4, AVRCP V1.6
- Bluetooth® transmitter frequency range:
2.4 GHz - 2.4835 GHz
- Bluetooth® transmitter power: ≤ 18 dBm (EIRP)
- Bluetooth® transmitter modulation:
GFSK, π/4 DQPSK, 8DPSK
- Input sensitivity:
 - Aux-In: 250 mV RMS (3.5 mm connector)
 - Mic-In: 20 mV RMS
 - Guitar-In / Line-In: 100 mV RMS
 - Bluetooth / USB input: -12 dBFS
- Product dimensions (W x H x D): 416 x 942 x 406 mm /
16.38" x 37.1" x 16.0"
- Net weight: 31 kg / 68.3 lbs
- Packaging dimensions (W x H x D): 491 x 1027 x 468 mm /
19.33" x 40.43" x 18.43"
- Gross weight: 34.9 kg / 76.9 lbs

10. TROUBLESHOOTING

Caution:





- Never try to repair the product by yourself. If you have any problems while using this product, check the following points before you request service.

System

The speaker will not turn on.

- Ensure that the speaker batteries are not drained. If not, use the AC power instead.

No response from some buttons / knobs

- The product may be in demo mode. In demo mode, all the input sources and buttons, except  /  and the volume and light pattern knobs, are disabled. With AC power connected, hold  and  simultaneously for more than 10 seconds to exit.
- The top panel may be locked. In this case, all buttons / knobs on the top panel, except , are disabled. Access the JBL app or restart the speaker to unlock it.

Sound

No sound from the speaker.

- Ensure that the speaker is powered on.
- Adjust volume.
- Ensure that a sound source is active and not muted.

No sound during phone calls while your phone is charging

- Remove the USB charging cable before making or answering a call.
- Enable the phone's speaker mode to output sound through the phone instead of the speaker.

Bluetooth

A device cannot connect with the speaker.

- Ensure that the Bluetooth function of the device is enabled.
- The speaker is already connected with another Bluetooth device. Hold  on the speaker for more than 10 seconds to disconnect and pair with a new device.

Poor audio quality from a connected Bluetooth device

- The Bluetooth reception is poor. Move the device closer to the speaker, or remove any obstacle between the device and speaker.

11. COMPLIANCE

The product complies with Commission Regulation (EU) 2023/826 ecodesign requirements for off mode, standby mode, and networked standby energy consumption of electrical and electronic household and office equipment.

1. Information on power consumption
 - Off mode: N/A
 - Standby mode: $\leq 0.5\text{ W}$
 - Networked standby mode: $\leq 2.0\text{ W}$
 - Networked standby mode if all wired ports are connected and all wireless ports are activated: $\leq 2.0\text{ W}$
2. The period after which the power management function switches the equipment automatically into:

Off/Standby mode	When the system is in normal operation	Switched to Off/ Standby mode after 20 minutes of inactivity
Networked Standby mode	When wireless network connection is activated	Switched to networked Standby mode after 20 minutes of inactivity

The maximum operation temperature is 45 °C.

No naked flame sources, such as lighted candles, should be placed on the apparatus.

12. TRADEMARK



The Bluetooth® word mark and logos are registered trademarks owned by Bluetooth SIG, Inc. and any use of such marks by HARMAN International Industries, Incorporated is under license. Other trademarks and trade names are those of their respective owners.



HARMAN International Industries,
Incorporated 8500 Balboa Boulevard,
Northridge, CA 91329 USA
www.jbl.com

© 2025 HARMAN International Industries, Incorporated.
All rights reserved.

JBL is a trademark of HARMAN International Industries, Incorporated, registered in the United States and/or other countries. Features, specifications and appearance are subject to change without notice.